

ILOT DE CUISINE

REF. 181804



FR

IMPORTANT: A lire attentivement. A conserver pour consultation ultérieure.

Montage/Installation

A monter et/ou à installer par un adulte.

Utilisation

Produit à usage domestique.

Usage intérieur exclusivement.

Entretien

Essuyer avec un chiffon humide. Terminer en essuyant avec un chiffon sec.

EN

IMPORTANT: Retain for future reference, read carefully.

Installation: To be assembled and / or installed by an adult.

Use: Product for domestic use. Indoor use only.

Maintenance and cleaning : Wipe with a damp cloth.

Finish by wiping with a dry cloth.

PR

IMPORTANTE: Informação a conservar, ler atentamente.

Instalação: Para ser montado ou instalado por um adulto

Uso: Produto à uso doméstico. Uso interior.

Manutenção e limpeza : Use um pano úmido. Limpe em seguida com um coágulo seco.

ES

IMPORTANTE: Guardar esta información para futuras referencias, leer atentamente.

Instalación: Debe montarse o ser instalado por un adulto.

Uso: Producto de uso domestico. Uso interior.

Mantenimiento y limpieza : Secar con un trapo húmedo. Acabar secando con un trapo

DE

WICHTIGE: Informationen, aufmerksam durchlesen und aufbewahren.

Installation: Von einem Erwachsenen aufzubauen oder zu installieren.

Verwendung: Für den Hausgebrauch. Ausschliesslich für innenraume Auswendung.

Wartung und reinigung: Mit einem sanftem Reinigungsmittel angefeuchteten Lumpe abtrocknen. Beenden, mit einem trocknen lumpen.

NE

BELANGRIJKE: informatie, bewaren voor toekomstig gebruik, zorgvuldig lezen.

Installatie: Te monteren of installeren door een volwassene

Gebruik: Product voor huishoudelijk gebruik. Alleen voor gebruik binnen.

Onderhoud En Reiniging: Met een vochtige doek schoonmaken. Op het einde afdrogen met een droge doek.

IT

IMPORTANTI: informazioni, conservare per futura consultazione, leggere con attenzione.

Installazione: Il montaggio o l'installazione devono essere eseguiti da un adulto

Uso: Prodotto per uso domestico. Usare unicamente all'interno.

Manutenzione E Pulizia: Utilizzare un panno umido. Asciugare con un panno asciutto.

RU

ВАЖНАЯ: информация, сохранять для использования в дальнейшем, внимательно прочесть.

Установка: Предназначены для монтажа или установки только взрослыми.

Использование: Изделия для домашнего использования. Только для использования в помещении.

Обслуживание И Чистка: Протрите влажной тряпкой, затем вытрите сухой тряпкой

PL

WAŻNE: Przed użyciem przeczytaj ulotkę. zachowaj ją na przyszłość

Montaż: Do montażu lub instalacji przez osobę dorosłą.









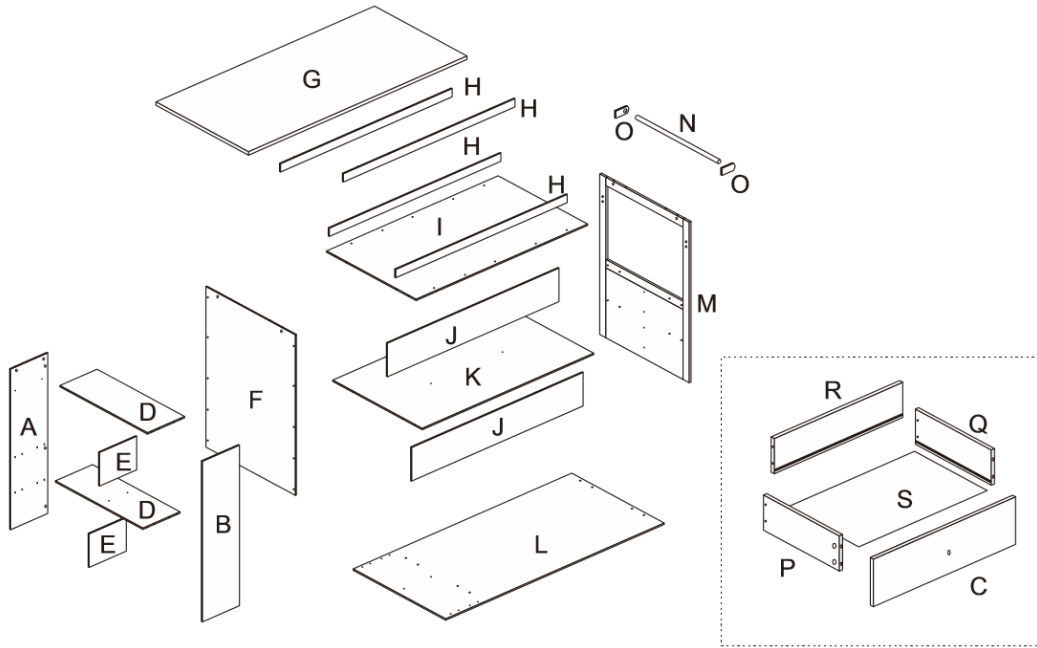





Użycie: Produkt gospodarstwa domowego. Tylko do użytku w pomieszczeniach

Instrukcje pielęgnacji: Czyść czystą wodą lub szmatką zwilżoną w wodzie. Wytrzyj suchą szmatką

ILOT DE CUISINE

REF. 181804



 ax36	 bx36	 cx38	 dx4	 ex16	 fx24
 gx8	 hx1	 ix4	 jx1	 kx1	 lx1
 mx1	 nx16	 ox4			

