

































A monter soi-même /to assemble /para montagem /para montaje /für
Montage /Te assembleren /Da montare/ Собирается самостоятельно

DESSERTS DE
CUISINE
Modèle CLAUD

																																							
1	1PC	2	1PC	3	1PC	4	1PC	5	1PC	6	1PC	7	1PC	8	1PC	9	1PC	10	1PC	11	1PC	12	2PCS	13	1PC	14	1PC	A	12PCS	B	18PCS	C	6PCS	D	2PCS	E	2PCS	F	8PCS
																																							
G	4PCS	H	2PCS	I	1PC	J	1PC	K	1PC	L	2PCS	M	2PCS	N	4PCS	O	1PC	P	2PCS	Q	2PCS	R	18PCS	S	1PC														

01

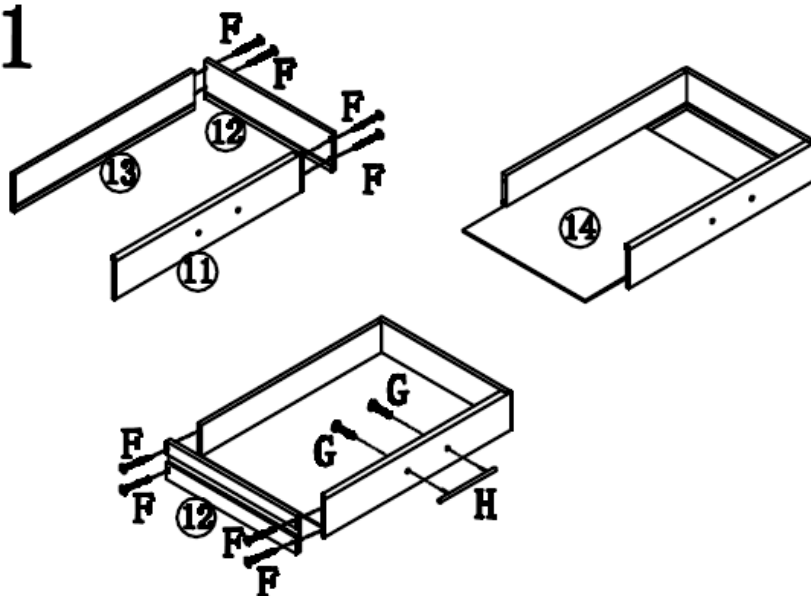

02

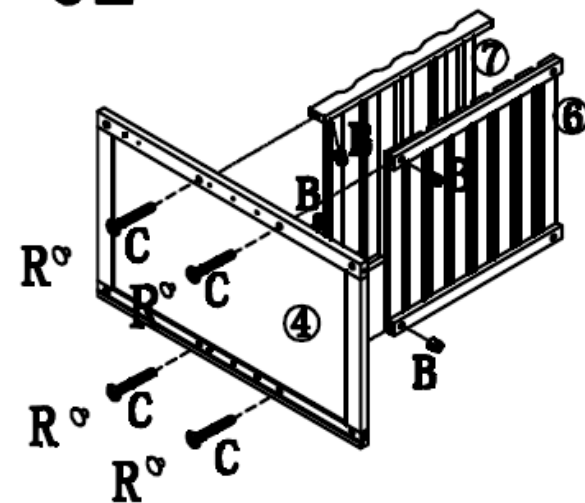

REF. 131375

Desserte de cuisine
Kitchen trolley
Carrinho de cozinha
Mesita de cocina
Servier-Wagen
Rolttafel
Carrello
Тележка

ATMOSPHERA
CREATEUR D'INTERIEUR

(FR) Utilisation domestique. Conditions d'entretien et de nettoyage : essuyer avec un chiffon humide. Terminer en essuyant avec un chiffon sec. A monter sur un sol plat et dégagé.

(GB) Domestic use. Maintenance & Cleaning conditions: Use a damp cloth. Wipe then with a dry cloth.

(P) Uso Doméstico. Condições de Manutenção e limpeza: Use um pano úmido. Limpe em seguida com um coágulo seco.

(E) Uso doméstico. Condiciones de servicio y mantenimiento : Secar con un trapo húmedo. Acabar secando con un trapo.

(D) Häusliche Verwendung. Bedingungen für Pflege & Reinigung: mit einem sanftem Reinigungsmittel angefeuchteten Lunte abtrocknen. Beenden, mit einem trocknen Lumpen.

































(NL) Huishoudelijk gebruik. Onderhoud en reiniging: met een vochtige doek schoonmaken. Op het einde afdrogen met een droge doek.

(I) Uso domestico. Condizioni di manutenzione e pulizia: utilizzare un panno umido. Asciugare con un panno asciutto.

(RU) Для использования в домашних условиях. Инструкция по уходу и чистке: протрите влажной тряпкой, затем вытрите сухой тряпкой.

A monter soi-même /to assemble /para montagem /para montaje /für
Montage /Te assembleren /Da montare/ Собирается самостоятельно

DESSERTTE DE
CUISINE
Modèle CLAUD

																																							
1	1PC	2	1PC	3	1PC	4	1PC	5	1PC	6	1PC	7	1PC	8	1PC	9	1PC	10	1PC	11	1PC	12	2PCS	13	1PC	14	1PC	A	12PCS	B	18PCS	C	6PCS	D	2PCS	E	2PCS	F	8PCS
																																							
G	4PCS	H	2PCS	I	1PC	J	1PC	K	1PC	L	2PCS	M	2PCS	N	4PCS	O	1PC	P	2PCS	Q	2PCS	R	18PCS	S	1PC														

03

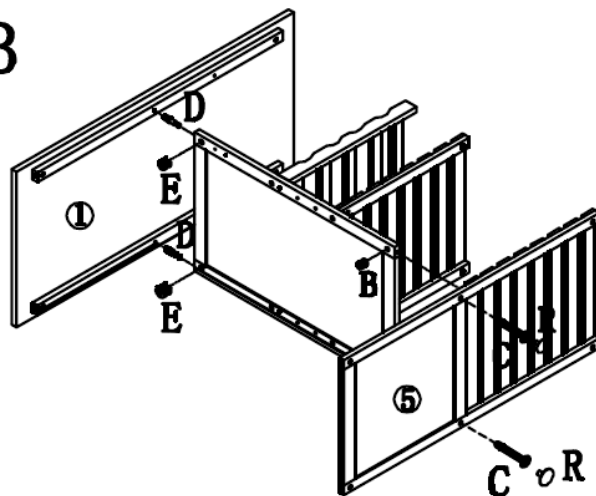

04

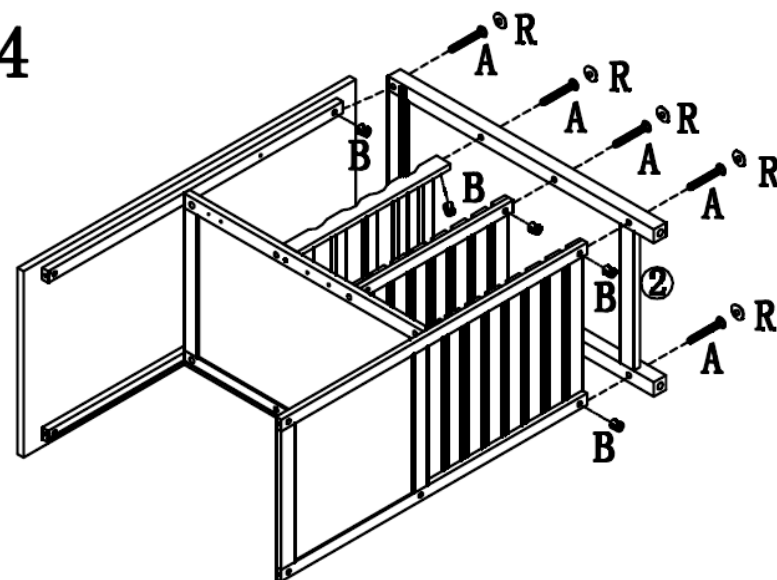

REF. 131375

Desserte de cuisine
Kitchen trolley
Carrinho de cozinha
Mesita de cocina
Servier-Wagen
Rolttafel
Carrello
Тележка



































ATMOSPHERA
CREATEUR D'INTERIEUR

- (FR) Utilisation domestique. Conditions d'entretien et de nettoyage : essuyer avec un chiffon humide. Terminer en essuyant avec un chiffon sec. A monter sur un sol plat et dégagé.
- (GB) Domestic use. Maintenance & Cleaning conditions: Use a damp cloth. Wipe then with a dry cloth.
- (P) Uso Doméstico. Condições de Manutenção e limpeza: Use um pano úmido. Limpe em seguida com um coágulo seco.
- (E) Uso doméstico. Condiciones de servicio y mantenimiento : Secar con un trapo húmedo. Acabar secando con un trapo.

- (D) Häusliche Verwendung. Bedingungen für Pflege & Reinigung: mit einem sanftem Reinigungsmittel angefeuchteten Lunte abtrocknen. Beenden, mit einem trocknen Lumpen.
- (NL) Huishoudelijk gebruik. Onderhoud en reiniging: met een vochtige doek schoonmaken. Op het einde afdrogen met een droge doek.
- (I) Uso domestico. Condizioni di manutenzione e pulizia: utilizzare un panno umido. Asciugare con un panno asciutto.
- (RU) Для использования в домашних условиях. Инструкция по уходу и чистке: протрите влажной тряпкой, затем вытрите сухой тряпкой.

A monter soi-même /to assemble /para montagem /para montaje /für
Montage /Te assembleren /Da montare/ Собирается самостоятельно

DESSERTS DE
CUISINE
Modèle CLAUD

																			
1 1PC	2 1PC	3 1PC	4 1PC	5 1PC	6 1PC	7 1PC	8 1PC	9 1PC	10 1PC	11 1PC	12 2PCS	13 1PC	14 1PC	A 12PCS	B 18PCS	C 6PCS	D 2PCS	E 2PCS	F 8PCS
																			
G 4PCS	H 2PCS	I 1PC	J 1PC	K 1PC	L 2PCS	M 2PCS	N 4PCS	O 1PC	P 2PCS	Q 2PCS	R 18PCS	S 1PC							

05

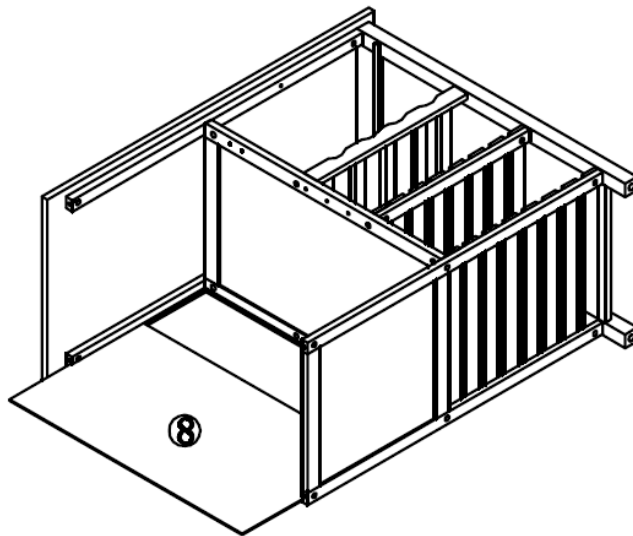

06

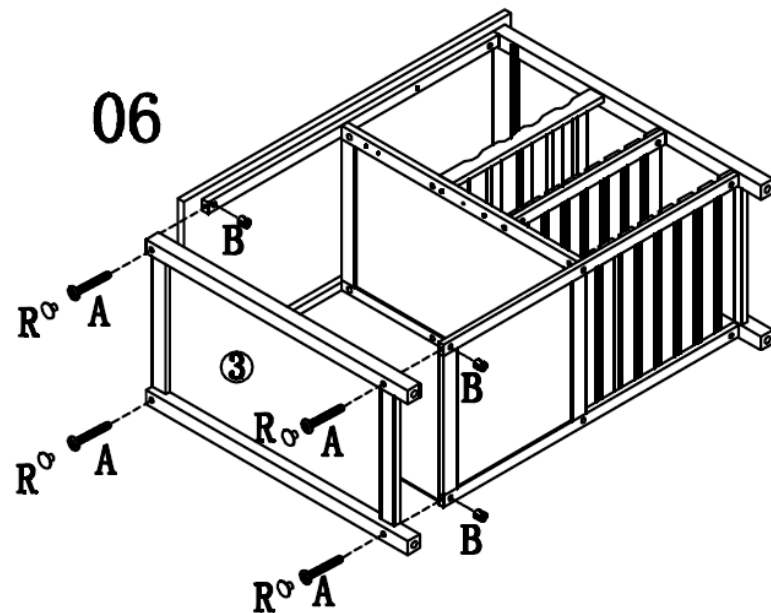

REF. 131375

Desserte de cuisine
Kitchen trolley
Carrinho de cozinha
Mesita de cocina
Servier-Wagen
Roltafel
Carrello
Тележка



































ATMOSPHERA
CREATEUR D'INTERIEUR

- (FR) Utilisation domestique. Conditions d'entretien et de nettoyage : essuyer avec un chiffon humide. Terminer en essuyant avec un chiffon sec. A monter sur un sol plat et dégagé.
- (GB) Domestic use. Maintenance & Cleaning conditions: Use a damp cloth. Wipe then with a dry cloth.
- (P) Uso Doméstico. Condições de Manutenção e limpeza: Use um pano úmido. Limpe em seguida com um coágulo seco.
- (E) Uso doméstico. Condiciones de servicio y mantenimiento : Secar con un trapo húmedo. Acabar secando con un trapo.

- (D) Häusliche Verwendung. Bedingungen für Pflege & Reinigung: mit einem sanftem Reinigungsmittel angefeuchteten Lunte abtrocknen. Beenden, mit einem trocknen Lumpen.
- (NL) Huishoudelijk gebruik. Onderhoud en reiniging: met een vochtige doek schoonmaken. Op het einde afdrogen met een droge doek.
- (I) Uso domestico. Condizioni di manutenzione e pulizia: utilizzare un panno umido. Asciugare con un panno asciutto.
- (RU) Для использования в домашних условиях. Инструкция по уходу и чистке: протрите влажной тряпкой, затем вытрите сухой тряпкой.

A monter soi-même /to assemble /para montagem /para montaje /für
Montage /Te assembleren /Da montare/ Собирается самостоятельно

DESSERTS DE
CUISINE
Modèle CLAUD

																																												
1	1PC	2	1PC	3	1PC	4	1PC	5	1PC	6	1PC	7	1PC	8	1PC	9	1PC	10	1PC	11	1PC	12	2PCS	13	1PC	14	1PC	A	12PCS	B	18PCS	C	6PCS	D	2PCS	E	2PCS	F	8PCS					
																																												
G	4PCS	H	2PCS	I	1PC	J	1PC	K	1PC	L	2PCS	M	2PCS	N	4PCS	O	1PC	P	2PCS	Q	2PCS	R	18PCS	S	1PC																			

07

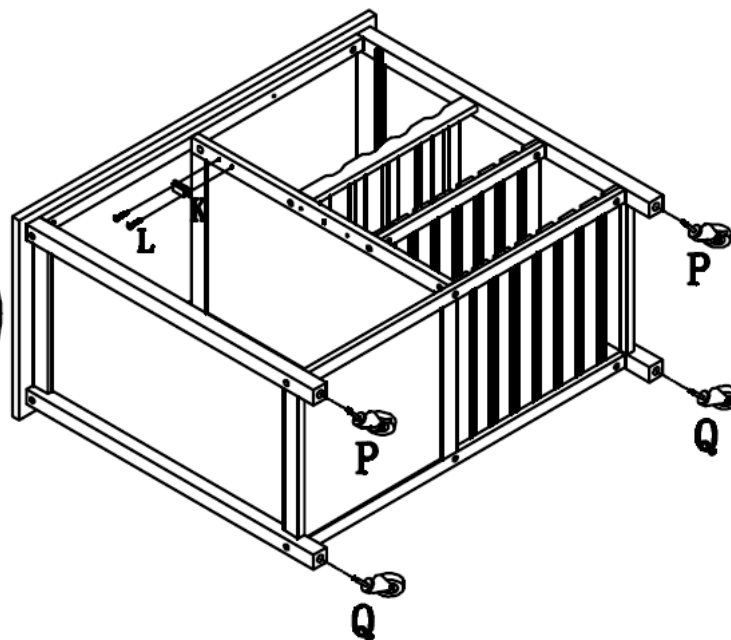
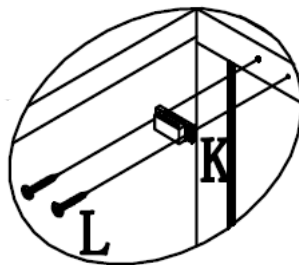

REF. 131375

Desserte de cuisine
Kitchen trolley
Carrinho de cozinha
Mesita de cocina
Servier-Wagen
Rolttafel
Carrello
Тележка

ATMOSPHERA
CREATEUR D'INTERIEUR®



































IMPORTÉ PAR / Imported by
Importado por / Importiert von
Ingevoerd door / Importato da
Импортер:
JJA
157, avenue Charles Floquet
93155 LE BLANC MESNIL Cedex - France
www.jja-sa.fr

- (FR) Utilisation domestique. Conditions d'entretien et de nettoyage : essuyer avec un chiffon humide. Terminer en essuyant avec un chiffon sec. A monter sur un sol plat et dégagé.
- (GB) Domestic use. Maintenance & Cleaning conditions: Use a damp cloth. Wipe then with a dry cloth.
- (P) Uso Doméstico. Condições de Manutenção e limpeza: Use um pano úmido. Limpe em seguida com um coágulo seco.
- (E) Uso doméstico. Condiciones de servicio y mantenimiento : Secar con un trapo húmedo. Acabar secando con un trapo.

- (D) Häusliche Verwendung. Bedingungen für Pflege & Reinigung: mit einem sanftem Reinigungsmittel angefeuchteten Lunte abtrocknen. Beenden, mit einem trocknen Lumpen.
- (NL) Huishoudelijk gebruik. Onderhoud en reiniging: met een vochtige doek schoonmaken. Op het einde afdrogen met een droge doek.
- (I) Uso domestico. Condizioni di manutenzione e pulizia: utilizzare un panno umido. Asciugare con un panno asciutto.
- (RU) Для использования в домашних условиях. Инструкция по уходу и чистке: протрите влажной тряпкой, затем вытрите сухой тряпкой.

A monter soi-même /to assemble /para montagem /para montaje /für
Montage /Te assembleren /Da montare/ Собирается самостоятельно

DESSERTS DE
CUISINE
Modèle CLAUD

																				
1 1PC	2 1PC	3 1PC	4 1PC	5 1PC	6 1PC	7 1PC	8 1PC	9 1PC	10 1PC	11 1PC	12 2PCS	13 1PC	14 1PC	A 12PCS	B 18PCS	C 6PCS	D 2PCS	E 2PCS	F 8PCS	
																				
G 4PCS	H 2PCS	I 1PC	J 1PC	K 1PC	L 2PCS	M 2PCS	N 4PCS	O 1PC	P 2PCS	Q 2PCS	R 18PCS	S 1PC								

08

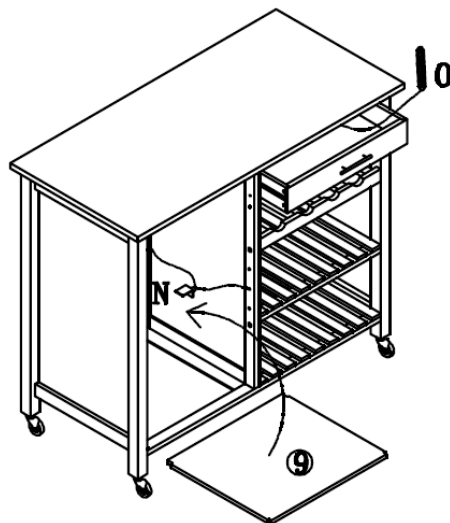

09

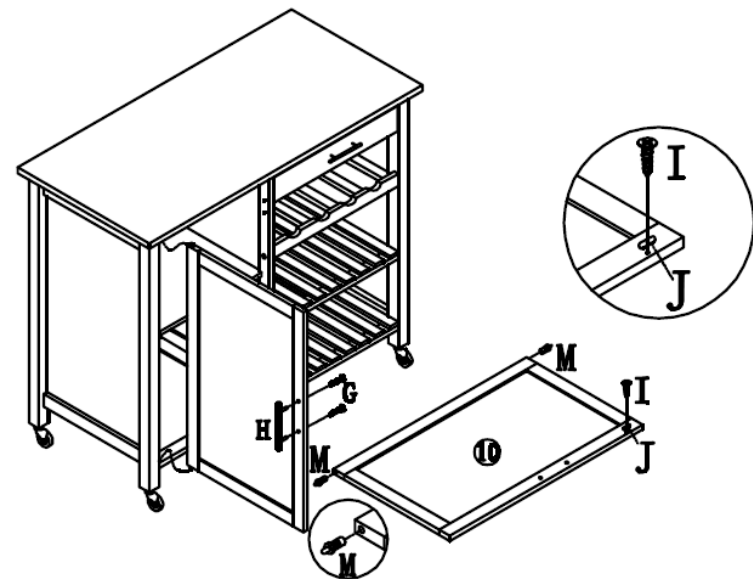

REF. 131375

Desserte de cuisine
Kitchen trolley
Carrinho de cozinha
Mesita de cocina
Servier-Wagen
Roltafel
Carrello
Тележка

ATMOSPHERA
CREATEUR D'INTERIEUR

- (FR) Utilisation domestique. Conditions d'entretien et de nettoyage : essuyer avec un chiffon humide. Terminer en essuyant avec un chiffon sec. A monter sur un sol plat et dégagé.
- (GB) Domestic use. Maintenance & Cleaning conditions: Use a damp cloth. Wipe then with a dry cloth.
- (P) Uso Doméstico. Condições de Manutenção e limpeza: Use um pano úmido. Limpe em seguida com um coágulo seco.
- (E) Uso doméstico. Condiciones de servicio y mantenimiento : Secar con un trapo húmedo. Acabar secando con un trapo.

- (D) Häusliche Verwendung. Bedingungen für Pflege & Reinigung: mit einem sanftem Reinigungsmittel angefeuchteten Lunte abtrocknen. Beenden, mit einem trocknen Lumpen.
- (NL) Huishoudelijk gebruik. Onderhoud en reiniging: met een vochtige doek schoonmaken. Op het einde afdrogen met een droge doek.
- (I) Uso domestico. Condizioni di manutenzione e pulizia: utilizzare un panno umido. Asciugare con un panno asciutto.
- (RU) Для использования в домашних условиях. Инструкция по уходу и чистке: протрите влажной тряпкой, затем вытрите сухой тряпкой.